

LA SORGENTE LUMINOSA DI QUESTO APPARECCHIO DEVE ESSERE SOSTITUITA ESCLUSIVAMENTE DAL PRODUTTORE O DAL SUO SERVIZIO ASSISTENZA O DA PERSONALE QUALIFICATO EQUIVALENTE

THE LIGHT SOURCE CONTAINED IN THIS LUMINAIRE SHALL ONLY BE REPLACED BY THE MANUFACTURER OR A SIMILAR QUALIFIED PERSON

1

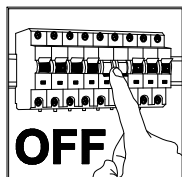

2 FISSAGGIO A SOFFITTO  
CEILING FIXING

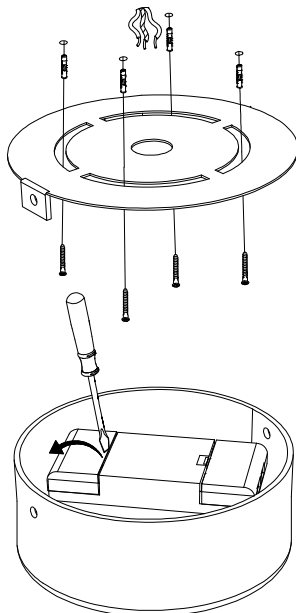

3 CONNESSIONE  
CONNECTION

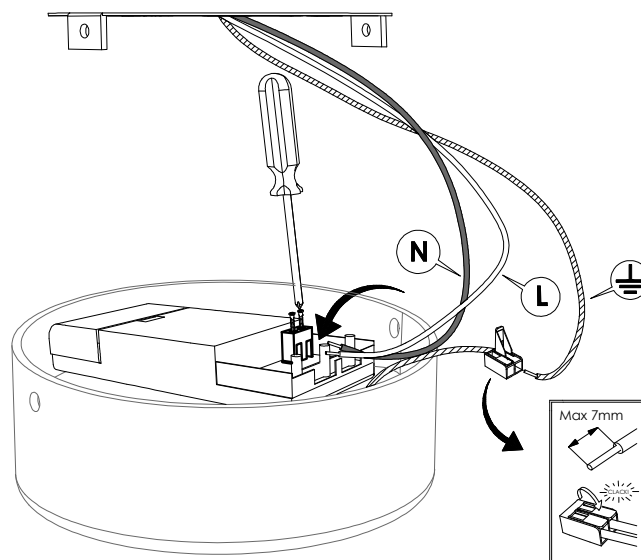

OPZIONE CON DIMMER  
OPTION WITH DIMMER

A.

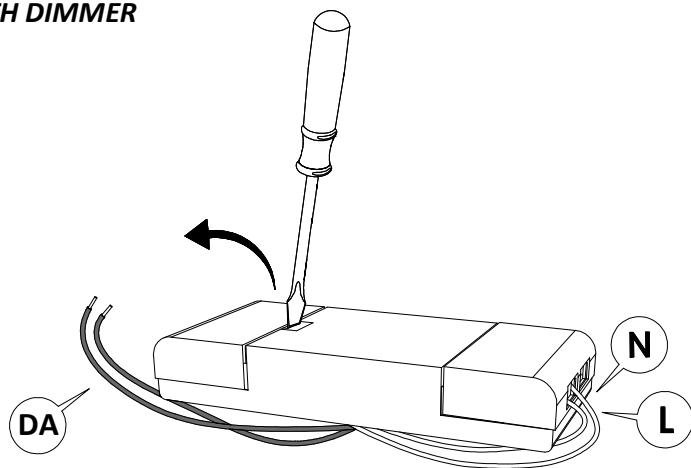

B.

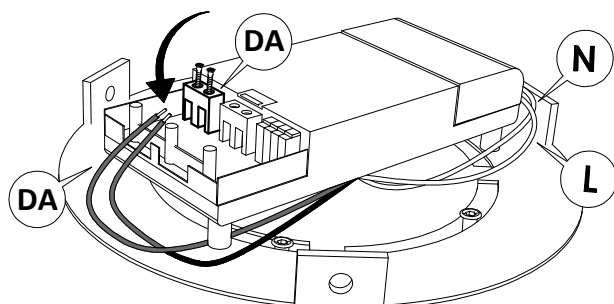

LA SORGENTE LUMINOSA DI QUESTO APPARECCHIO DEVE ESSERE SOSTITUITA ESCLUSIVAMENTE DAL PRODUTTORE O DAL SUO SERVIZIO ASSISTENZA O DA PERSONALE QUALIFICATO EQUIVALENTE

THE LIGHT SOURCE CONTAINED IN THIS LUMINAIRE SHALL ONLY BE REPLACED BY THE MANUFACTURER OR A SIMILAR QUALIFIED PERSON

### 4 REGOLAZIONE CAVO CABLE ADJUSTMENT

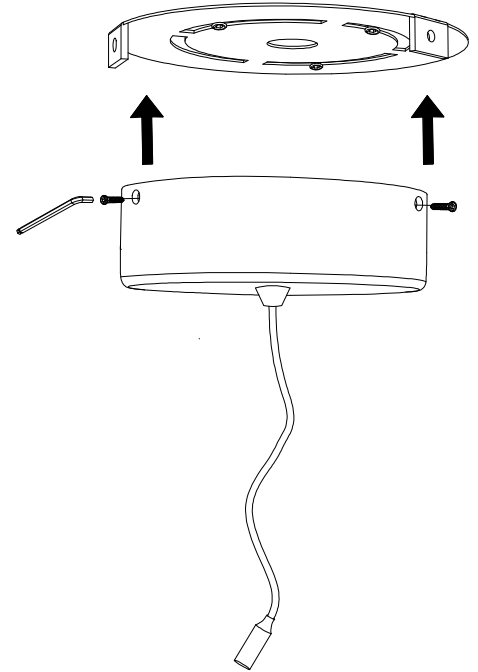
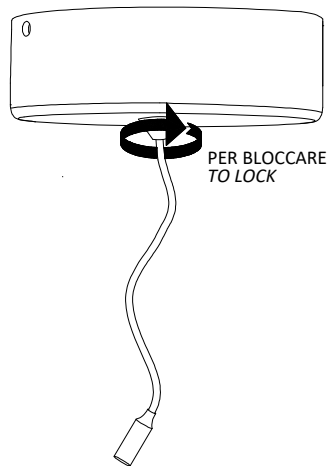
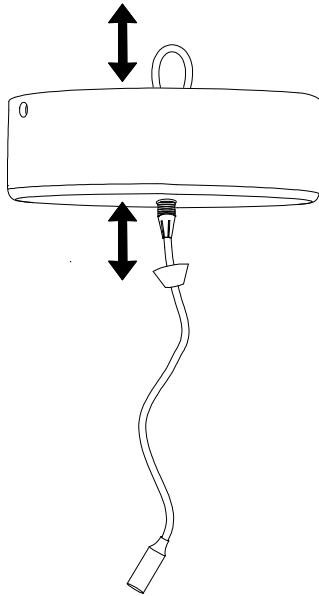

### 5 MONTAGGIO SISTEMA SYSTEM ASSEMBLY

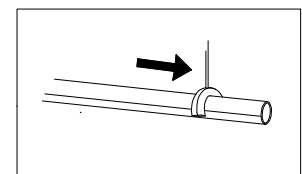
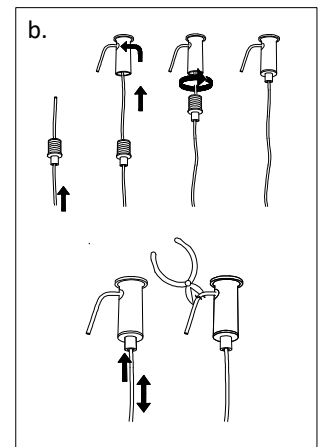
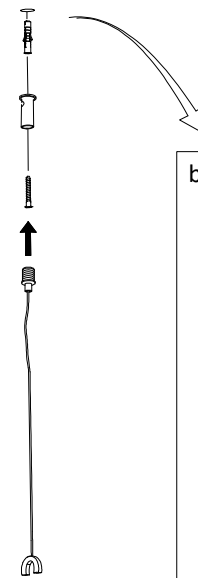
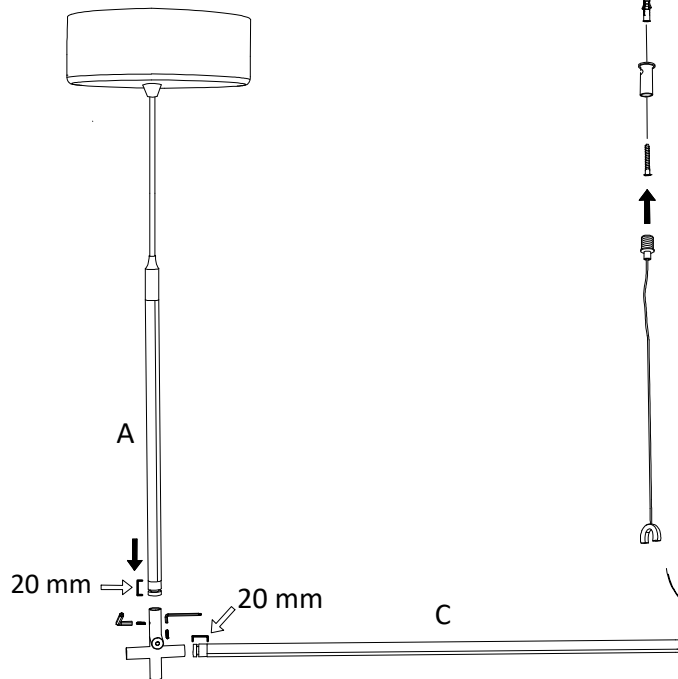
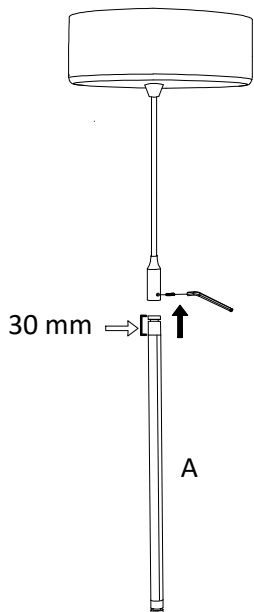

LA SORGENTE LUMINOSA DI QUESTO APPARECCHIO DEVE ESSERE SOSTITUITA ESCLUSIVAMENTE DAL PRODUTTORE O DAL SUO SERVIZIO ASSISTENZA O DA PERSONALE QUALIFICATO EQUIVALENTE

THE LIGHT SOURCE CONTAINED IN THIS LUMINAIRE SHALL ONLY BE REPLACED BY THE MANUFACTURER OR A SIMILAR QUALIFIED PERSON

5

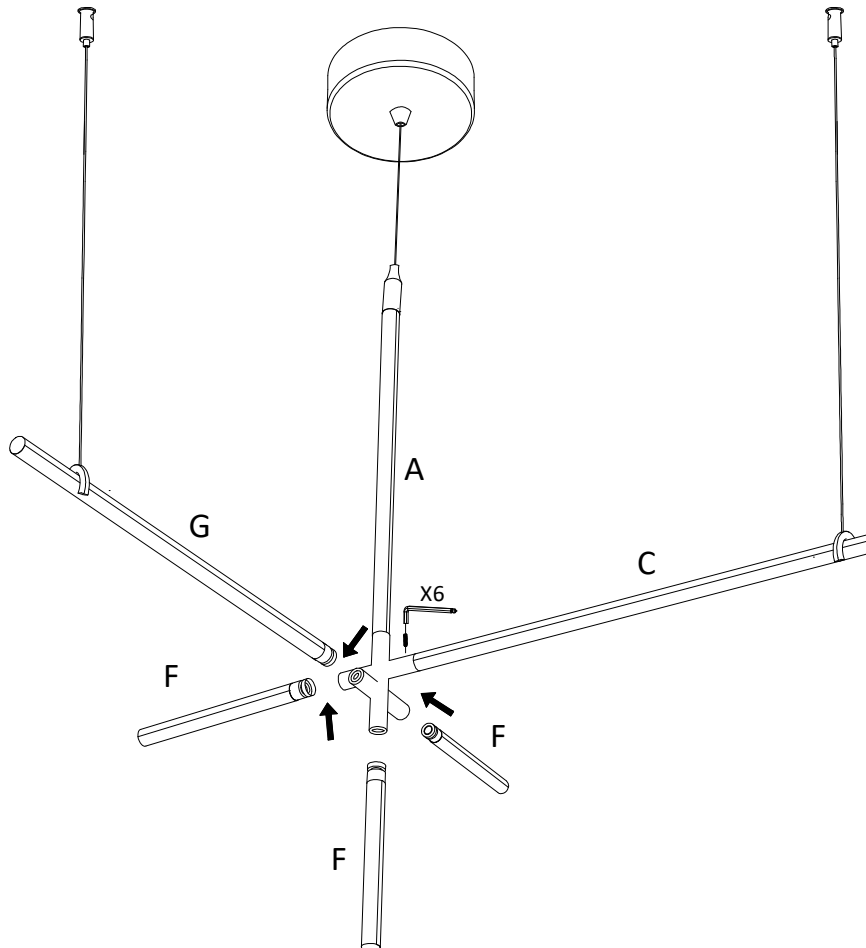

6

